



TRACKED EXCAVATOR | JS160/180 NLC/LC

Operating weight: 17,866 - 20,480 Engine power: 97kW (130hp) Bucket capacity: 0.25 – 0.99m³



STRENGTH BUILT IN.

The JCB JS160 and JS180 are the culmination of 48 years' tracked excavator expertise, offering performance and productivity without compromise. Designed and developed using our Efficient Design philosophy, these 17 to 20 tonne machines feature many efficiency, comfort and safety innovations. And now, with a new JCB Stage V engine, they produce their lowest emissions yet.



Our machines have durability built in with a high-strength, fully-welded, X-frame undercarriage, rigid upper structure and doors that stand the test of time.



PRODUCTIVITY & PERFORMANCE.

Saving money and time is more important than ever, so we've made sure the JS160/180's componentry – including the DIESELMAX Stage V – works in perfect harmony. In turn, you get a machine that's as efficient and productive as possible.



EASY TO USE.

The light, intuitive controls of both machines are easy to use, while the 7" colour screen keeps the operator in full control, equalling greater productivity.



LESS SERVICING, MORE SERVICE.

We've designed the JS160 and JS180 to be low maintenance and easily serviceable, making them affordable, efficient and highly productive, with more uptime.

JCB LIVELINK.

JCB LiveLink is an innovative telematics system that lets you monitor and manage your machines remotely online, via your laptop, tablet or smartphone.

STATIC DIMENSIONS

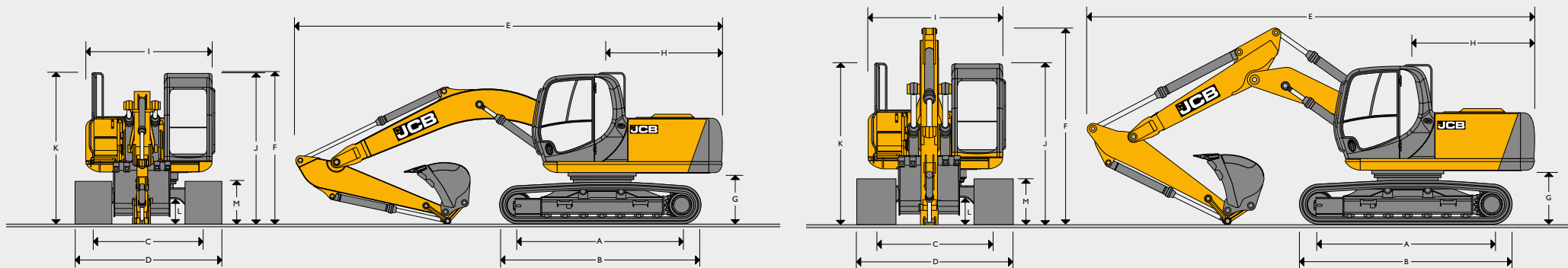

STATIC DIMENSIONS

Dimensions in mm	JS160						JS180					
	NLC			LC			NLC			LC		
A Track length on ground	3090			3090			3370			3370		
B Undercarriage overall length	3940			3940			4170			4170		
C Track gauge	1990			2200			1990			2170		
D Width over tracks (500mm trackshoes)	2490			-			2490			-		
D Width over tracks (600mm trackshoes)	2590			2800			2590			2770		
D Width over tracks (700mm trackshoes)	2690			2900			2690			2870		
D Width over tracks (800mm trackshoes)	-			3000			-			2970		
D Width over tracks (900mm trackshoes)	-			3100			-			-		
Boom options	Monoboom 5.15m			T.A.B. 5.35m			Monoboom 5.15m			T.A.B. 5.35m		
Dipper lengths	2.25m	2.7m	3.05m	2.25m	2.7m	3.05m	2.25m	2.7m	3.05m	2.25m	2.7m	3.05m
E Transport length	8338	8298	8388	8624	8646	8616	8366	8326	8415	8652	8674	8644
F Transport height	3140	3140	3140	3162	3162	3162	3140	3140	3140	3162	3162	3162
Dimensions in mm												
G Counterweight clearance	1050						1072					
H Tailswing radius	2338						2338					
I Width of superstructure	2470						2470					
J Height over cab	2965						2987					
K Height over grab rail	3140						3162					
L Ground clearance	470						486					
M Track height	880						885					

ENGINE	
Model	JCB DIESELMAX Stage V Compliant
Type	4-stroke, 4-cylinder in-line, common rail, direct injection, turbocharged and intercooled diesel
Rated power (net)	97kW (130hp) at 2200rpm
Piston Displacement	4.8 litres
Air Filtration	Dry element with secondary safety element and in cab warning indicator
Starting system	24 volt
Batteries	2 x 12 volt
Alternator	24 volt 100 amp

SWING SYSTEM	
Swing motor	Axial piston type
Swing brake	Hydraulic braking plus automatic spring applied disc type parking brake
Swing torque	35 kNm
Swing speed	10.4 rpm
Swing gear	Large diameter, internally toothed fully sealed grease bath lubricated

UNDERCARRIAGE					
Carriage options	NLC – Narrow long carriage and LC – Long carriage				
Construction	Fully welded, 'X' frame type with central bellyguarding and sloping sidemembers with dirt relief holes under top rollers.				
Recovery point	Front and rear				
Track shoes	500mm	600mm	700mm	800mm	900mm
JSI60 NLC (LC)	●	● (□)	● (□)	□	□
JSI80 NLC (LC)	●	● (□)	● (□)	(□)	
Upper & lower rollers	Heat treated, sealed and lubricated				
Track adjustment	Grease cylinder type				
Track idler	Sealed and lubricated, with spring cushioned recoil				
Track type	Sealed and lubricated				
Rollers and Shoes (each side)	JSI60		JSI80		
Track guides	1		2		
Lower rollers	7		7		
Upper rollers	2		2		
Track shoes	43		46		

● Triple grouser (NLC) □ Triple grouser (LC)

HYDRAULIC SYSTEM	
Open centered, negative control hydraulic system with twin variable flow piston pumps providing flow-on-demand	
Pumps	
Main pumps	2 variable displacement axial piston type
Maximum flow	2 x 164 L/min
Servo pump	Gear type
Maximum flow	20.5 L/min
Control valve	
A combined ten spool control valve with auxiliary service spool as standard	
Relief valve settings	
Boom/Arm/Bucket	314 bar
With power boost	343 bar
Swing circuit	279 bar
Travel circuit	343 bar
Pilot control	40 bar
Filtration	
In tank	150 micron, suction strainer
Main return line	10 micron, glass fibre element
Pilot line	10 micron, paper element
Hydraulic hammer return	10 micron, reinforced microform element

TRACK DRIVE		
Type	Fully hydrostatic, two speed with autoshift between high and low speed	
Travel motors	Variable swash axial piston type, fully guarded within undercarriage frame	
Final drive	Planetary reduction, bolt-on sprockets	
Service brake	Hydraulic counter balance valve	
Park brake	Disc type, spring applied, automatic hydraulic release	
Gradeability	70% (35 deg) continuous	
Travel speed	JSI60	JSI80
	High – 5.5 kph	High – 5.5 kph
	Low – 3.2 kph	Low – 3.2 kph
Tractive effort	167 kNm	167 kNm

SERVICE CAPACITIES		
Fuel tank	litres	220
Engine coolant	litres	19.7
Engine oil	litres	20.4
Swing reduction gear	litres	6.0
Track reduction gear (each side)	litres	4.4
Hydraulic system	litres	142
Hydraulic tank	litres	73.0
DEF fluid capacity	litres	54.0

WEIGHTS AND GROUND BEARING PRESSURES

		500mm shoes	600mm shoes	700mm shoes	800mm shoes	900mm shoes
JSI60 LC MONO – Machine equipped with 5.15m Monoboomb, 3.05m Dipper, 0.87m ³ GP Bucket, operator and full fuel tank.						
Machine weight	kg	-	18172	18433	18673	18933
Ground bearing pressure	kg/cm ²	-	0.45	0.39	0.34	0.31
JSI60 NLC MONO. – Machine equipped with 5.15m Monoboomb, 3.05m Dipper, 0.87m ³ GP Bucket, operator and full fuel tank.						
Machine weight	kg	17866	18104	18364	-	-
Ground bearing pressure	kg/cm ²	0.53	0.45	0.39	-	-
JSI60 LC TAB – Machine equipped with 5.35m T.A.B. boom, 3.05m Dipper, 0.87m ³ GP Bucket, operator and full fuel tank.						
Machine weight	kg	-	18724	18985	19225	19485
Ground bearing pressure	kg/cm ²	-	0.46	0.4	0.35	0.32
JSI60 NLC TAB – Machine equipped with 5.35m T.A.B. boom, 3.05m Dipper, 0.87m ³ GP Bucket, operator and full fuel tank.						
Machine weight	kg	18418	18656	18916	-	-
Ground bearing pressure	kg/cm ²	0.54	0.46	0.4	-	-
JSI80 LC MONO – Machine equipped with 5.15m Monoboomb, 3.05m Dipper, 0.87m ³ GP Bucket, operator and full fuel tank.						
Machine weight	kg	-	19393	19671	19928	-
Ground bearing pressure	kg/cm ²	-	0.48	0.41	0.37	-
JSI80 NLC MONO – Machine equipped with 5.15m Monoboomb, 3.05m Dipper, 0.87m ³ GP Bucket, operator and full fuel tank.						
Machine weight	kg	19072	19326	19604	-	-
Ground bearing pressure	kg/cm ²	0.56	0.48	0.41	-	-
JSI80 LC TAB – Machine equipped with 5.35m T.A.B. boom, 3.05m Dipper, 0.87m ³ GP Bucket, operator and full fuel tank.						
Machine weight	kg	-	19945	20223	20480	-
Ground bearing pressure	kg/cm ²	-	0.49	0.43	0.38	-
JSI80 NLC TAB – Machine equipped with 5.35m T.A.B. boom, 3.05m Dipper, 0.87m ³ GP Bucket, operator and full fuel tank.						
Machine weight	kg	19624	19878	20156	-	-
Ground bearing pressure	kg/cm ²	0.58	0.49	0.43	-	-

BUCKET AND ARM COMBINATION - MONOBOOM										
Bucket options		GP Bucket					HD Bucket			
Bucket width	mm	457	610	762	1067	1219	600	1000	1200	1300
Bucket capacity	m ³	0.27	0.33	0.46	0.73	0.87	0.38	0.70	0.91	0.99
Bucket weight	kg	339	368	414	508	645	442	594	675	708
JSI60 NLC										
2.25m Quickhitch (No Quickhitch)		□ (□)	□ (□)	□ (□)	■ (□)	● (■)	□ (□)	■ (□)	● (■)	× (●)
2.70m Quickhitch (No Quickhitch)		□ (□)	□ (□)	□ (□)	■ (□)	× (●)	□ (□)	● (□)	× (●)	× (●)
3.05m Quickhitch (No Quickhitch)		□ (□)	□ (□)	□ (□)	● (■)	× (●)	□ (□)	● (■)	× (●)	× (×)
JSI60 LC										
2.25m Quickhitch (No Quickhitch)		□ (□)	□ (□)	□ (□)	□ (□)	■ (□)	□ (□)	□ (□)	■ (□)	● (■)
2.70m Quickhitch (No Quickhitch)		□ (□)	□ (□)	□ (□)	□ (□)	● (■)	□ (□)	■ (□)	● (■)	● (■)
3.05m Quickhitch (No Quickhitch)		□ (□)	□ (□)	□ (□)	● (□)	× (●)	□ (□)	● (□)	× (●)	× (●)
JSI80 NLC										
2.25m Quickhitch (No Quickhitch)		□ (□)	□ (□)	□ (□)	□ (□)	■ (□)	□ (□)	□ (□)	■ (□)	● (■)
2.70m Quickhitch (No Quickhitch)		□ (□)	□ (□)	□ (□)	□ (□)	● (■)	□ (□)	■ (□)	● (■)	● (■)
3.05m Quickhitch (No Quickhitch)		□ (□)	□ (□)	□ (□)	■ (□)	● (■)	□ (□)	● (□)	× (●)	× (●)
JSI80 LC										
2.25m Quickhitch (No Quickhitch)		□ (□)	□ (□)	□ (□)	□ (□)	□ (□)	□ (□)	□ (□)	□ (□)	■ (□)
2.70m Quickhitch (No Quickhitch)		□ (□)	□ (□)	□ (□)	□ (□)	● (■)	□ (□)	□ (□)	● (■)	● (■)
3.05m Quickhitch (No Quickhitch)		□ (□)	□ (□)	□ (□)	■ (□)	● (■)	□ (□)	● (□)	× (●)	× (●)

□ = Suitable for general excavating (materials up to 2000kg/cu.m)

■ = Suitable for light excavating (materials up to 1600kg/cu.m.)

● = Suitable for grading and loading (materials up to 1200kg/cu.m)

× = Not warranted

* Bucket capacity recommendations calculated for Monoboomb only.

WORKING RANGE - JSI60 NLC/LC MONOBOOM 5.15M

Dipper length:		2.25m	2.70m	3.05m	
A	Maximum digging reach	mm	8524.7	8914.6	9282.6
B	Maximum digging reach (on ground)	mm	8336.8	8735.3	9110.6
C	Maximum digging depth	mm	5343.2	5771.6	6111
D	Maximum digging height	mm	8942.2	9133.2	9522.9
E	Maximum dumping height	mm	6557.6	6756.9	7097.7
F	Maximum vertical wall cut depth	mm	4962.2	5431.5	5645.6
G	Minimum swing radius	mm	3000	3000	3000
	Bucket rotation		182°	182°	182°
	Maximum dipper tearout	kNm	85.8	74.7	68.6
	Maximum bucket tearout	kNm	116.1	116.1	116.1

WORKING RANGE - JSI80 NLC/LC MONOBOOM 5.15M

Dipper length:		2.25m	2.70m	3.05m	
A	Maximum digging reach	mm	8524.7	8920	9282.6
B	Maximum digging reach (on ground)	mm	8333.1	8737.2	9107.2
C	Maximum digging depth	mm	5326	5763	6093.7
D	Maximum digging height	mm	8959.2	9145.3	9539.9
E	Maximum dumping height	mm	6574.6	6773.9	7114.8
F	Maximum vertical wall cut depth	mm	4944.5	5428.7	5627.7
G	Minimum swing radius	mm	3000	3000	3000
	Bucket rotation		182°	182°	182°
	Maximum dipper tearout	kNm	85.8	74.7	68.6
	Maximum bucket tearout	kNm	116.1	116.1	116.1

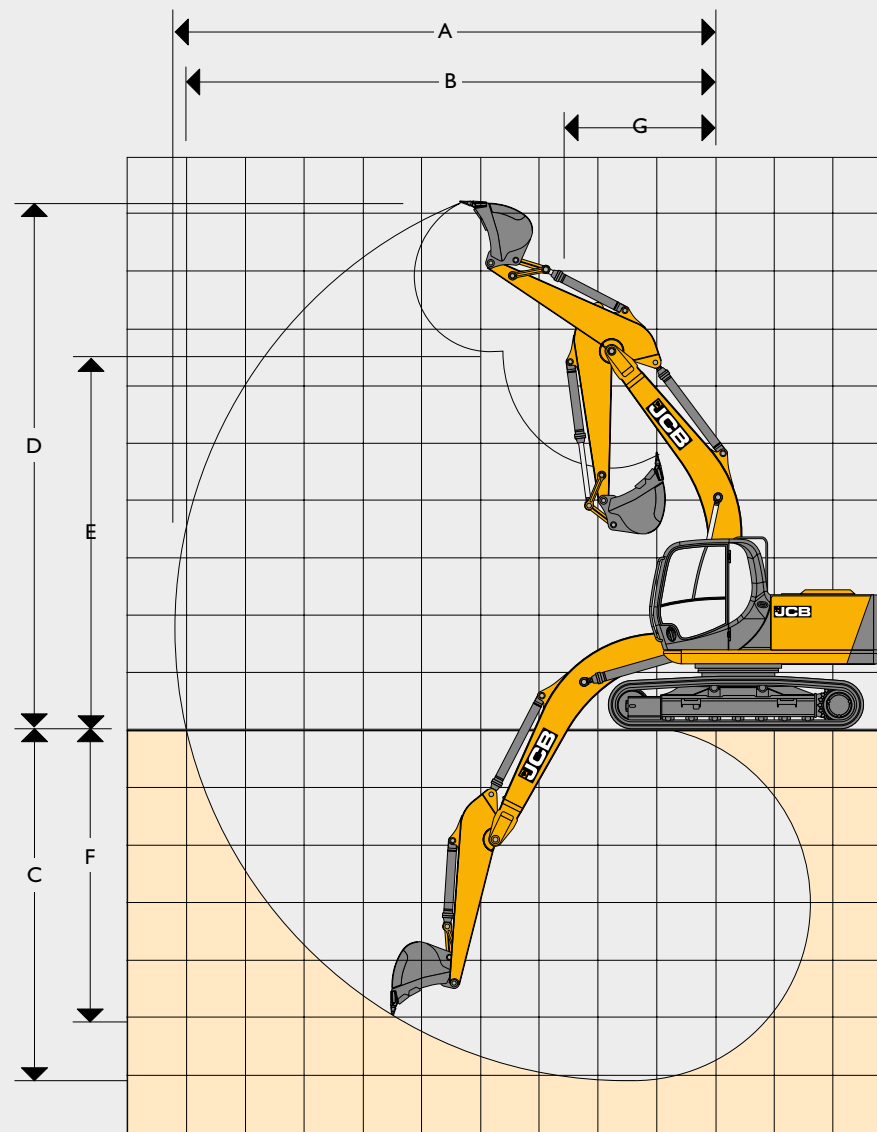

WORKING RANGE - JSI60 NLC/LC T.A.B. 5.35M







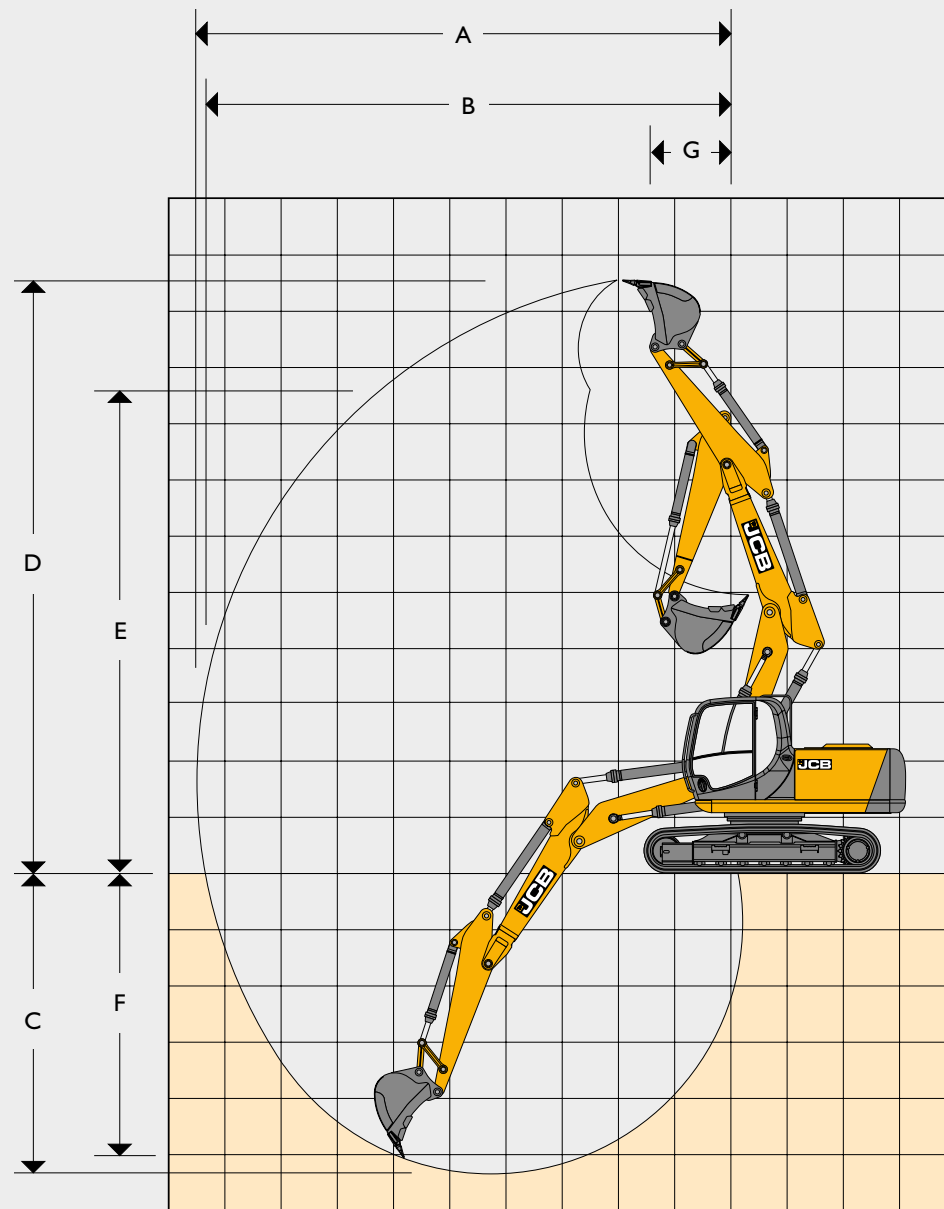





Dipper length:		2.25m	2.70m	3.05m
A	Maximum digging reach	mm 8831	9260	9592
B	Maximum digging reach (on ground)	mm 8652	9094	9463
C	Maximum digging depth	mm 5376	5808	6130
D	Maximum digging height	mm 10226	10652	10800
E	Maximum dumping height	mm 7976	8366	8667
F	Maximum vertical wall cut depth	mm 4254	4721	5233
G	Minimum swing radius	mm 2170	2227	2587
	Bucket rotation	182°	182°	182°
	Maximum dipper tearout	kNm 85.8	74.7	68.7
	Maximum bucket tearout	kNm 116.1	116.1	116.1

WORKING RANGE - JSI80 NLC/LC T.A.B. 5.35M













Dipper length:		2.25m	2.70m	3.05m
A	Maximum digging reach	mm 8831	9260	9592
B	Maximum digging reach (on ground)	mm 8652	9094	9463
C	Maximum digging depth	mm 5354	5786	6108
D	Maximum digging height	mm 10248	10674	10822
E	Maximum dumping height	mm 8000	8444	8672
F	Maximum vertical wall cut depth	mm 4332	4699	5211
G	Minimum swing radius	mm 2170	2227	2587
	Bucket rotation	182°	182°	182°
	Maximum dipper tearout	kNm 85.8	74.7	68.7
	Maximum bucket tearout	kNm 116.1	116.1	116.1















LIFT CAPACITIES – DIPPER LENGTH: 2.25M, 5.15M MONOBOOM, TRACKSHOES: 700MM, NO BUCKET. JSI60 LC MONO

Reach	1.5m		3m		4.5m		6m		7.5m		Capacity at Max Reach			
														
Load Point Ht.	kg	kg	kg	kg	kg	kg	kg	kg	kg	kg	kg	kg	mm	
7.5m												3880*	3880*	4495
6.0m												3340*	3340*	5961
4.5m					5530*	5530*	5000	3660				3190*	2990	6797
3.0m					6900*	5360	4870	3530				3220*	2670	7230
1.5m					7260	5060	4720	3400				3430*	2560	7331
0m			5270*	5270*	7070	4900	4620	3300				3640	2630	7116
- 1.5m	5970*	5970*	10710*	9160	7030	4860	4590	3280				4080	2930	6554
- 3.0m			10790*	9330	7120	4940						5250	3740	5535
- 4.5m														

LIFT CAPACITIES – DIPPER LENGTH: 2.70M, 5.15M MONOBOOM, TRACKSHOES: 700MM, NO BUCKET. JSI60 LC MONO

Reach	1.5m		3m		4.5m		6m		7.5m		Capacity at Max Reach			
														
Load Point Ht.	kg	kg	kg	kg	kg	kg	kg	kg	kg	kg	kg	kg	mm	
7.5m												2820*	2820*	5128
6.0m							3840*	3750				2500*	2500*	6449
4.5m					4980*	4980*	4610*	3690				2410*	2410	7228
3.0m			9630*	9630*	6370*	5440	4890	3550	3190*	2530		2440*	2440*	7636
1.5m			5060*	5060*	7300	5100	4730	3400	3400	2460		2600*	2350	7732
0m			6390*	6390*	7070	4890	4600	3280	3150*	2420		2900*	2410	7529
- 1.5m	5750*	5750*	10070*	9060	6990	4810	4550	3230				3500*	2640	7000
- 3.0m	9790*	9790*	11600*	9190	7030	4860	4600	3290				4550	3250	6058
- 4.5m			8470*	8470*								5590*	5170	4443

LIFT CAPACITIES – DIPPER LENGTH: 3.05M, 5.15M MONOBOOM, TRACKSHOES: 700MM, NO BUCKET. JSI60 LC MONO



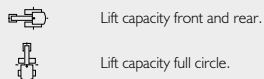

Reach	1.5m		3m		4.5m		6m		7.5m		Capacity at Max Reach			
														
Load Point Ht.	kg	kg	kg	kg	kg	kg	kg	kg	kg	kg	kg	kg	mm	
7.5m												2440*	2440*	5707
6.0m							3880*	3760				2160*	2160*	6916
4.5m							4260*	3680	2690*	2540		2070*	2070*	7647
3.0m			8500*	8500*	5880*	5440	4870*	3520	3430	2490		2070*	2070*	8033
1.5m			6080*	6080*	7270	5060	4680	3350	3350	2410		2170*	2130	8124
0m			6140*	6140*	6980	4800	4530	3210	3280	2350		2380*	2170	7931
- 1.5m	4890*	4890*	9020*	8850	6870	4700	4460	3140				2780*	2360	7431
- 3.0m	8390*	8390*	11970*	8960	6890	4720	4480	3170				3610*	2830	6553
- 4.5m			9340*	9250	6330*	4890						5160*	4130	5101



Notes:

1. The above loads are in compliance with SAE and ISO Hydraulic Excavator Lift Capacity Standards.
2. They do not exceed 87% of hydraulic lifting capacity or 75% of tipping load.
3. Rated loads marked with an asterisk(*) are limited by hydraulic capacity rather than tipping load.

LIFT CAPACITIES – DIPPER LENGTH: 2.25M, 5.15M MONOBOOM, TRACKSHOES: 500MM, NO BUCKET. JSI60 NLC MONO

Reach	1.5m		3m		4.5m		6m		7.5m		Capacity at Max Reach			
														
Load Point Ht.	kg	kg	kg	kg	kg	kg	kg	kg	kg	kg	kg	kg	mm	
7.5m												3880*	3880*	4495
6.0m												3340*	3280	5961
4.5m					5530*	5000	4860	3220				3190*	2620	6797
3.0m					6900*	4680	4720	3100				3230*	2230	7230
1.5m					7040	4380	4580	2960				3410	2230	7331
0m			5270*	5270*	6850	4230	4470	2870				3520	2290	7116
- 1.5m	5970*	5970*	10710*	7740	6820	4190	4450	2850				3950	2550	6554
- 3.0m			10790*	7890	6910	4270						5090	3250	5535
- 4.5m														

LIFT CAPACITIES – DIPPER LENGTH: 2.70M, 5.15M MONOBOOM, TRACKSHOES: 500MM, NO BUCKET. JSI60 NLC MONO

Reach	1.5m		3m		4.5m		6m		7.5m		Capacity at Max Reach			
														
Load Point Ht.	kg	kg	kg	kg	kg	kg	kg	kg	kg	kg	kg	kg	mm	
7.5m												2820*	2820*	5128
6.0m							3840*	3310				2500*	2500*	6449
4.5m							4610*	3250				2410*	2390	7228
3.0m			9630*	8720*	7980*	4980	4750	3110	3190*	2210		2440*	2140	7636
1.5m			5060*	5060*	6370	4750	4580	2960	3290	2150		2600*	2050	7732
0m			6390*	6390*	7090	4420	4460	2850	3150*	2100		2900*	2090	7529
- 1.5m	5750*	5750*	10070*	7630	6850	4210	4410	2800				3500*	2300	7000
- 3.0m	9790*	9790*	11600*	7760	6770	4150	4460	2850				4400	2820	6058
- 4.5m			8470*	8050	6820*	4190						5590*	4480	4443

LIFT CAPACITIES – DIPPER LENGTH: 3.05M, 5.15M MONOBOOM, TRACKSHOES: 500MM, NO BUCKET. JSI60 NLC MONO

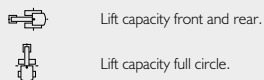

Reach	1.5m		3m		4.5m		6m		7.5m		Capacity at Max Reach			
														
Load Point Ht.	kg	kg	kg	kg	kg	kg	kg	kg	kg	kg	kg	kg	mm	
7.5m												2440*	2440*	5707
6.0m							3880*	3310				2160*	2160*	6916
4.5m							4260*	3240	2690*	2220		2070*	2070*	7647
3.0m			8500*	8500*	5880*	4750	4720	3080	3320	2170		2070*	1920	8033
1.5m			6080*	6080*	7050	4370	4530	2910	3240	2090		2170*	1840	8124
0m			6140*	6140*	6770	4130	4390	2770	3170	2030		2380*	1870	7931
- 1.5m	4890*	4890*	9020*	7430	6650	4030	4310	2710				2780*	2040	7431
- 3.0m	8390*	8390*	11970*	7530	6670	4050	7340	2730				3610*	2450	6553
- 4.5m			9340*	7810	6330*	4220						5160*	3580	5101











Notes:

1. The above loads are in compliance with SAE and ISO Hydraulic Excavator Lift Capacity Standards.
2. They do not exceed 87% of hydraulic lifting capacity or 75% of tipping load.
3. Rated loads marked with an asterisk(*) are limited by hydraulic capacity rather than tipping load.











LIFT CAPACITIES – DIPPER LENGTH: 2.25M, 5.35M T.A.B., TRACKSHOES: 700MM, NO BUCKET. JSI60 LC T.A.B.

Reach	3m		4.5m		6m		7.5m		Capacity at Max Reach		
											
Load Point Ht.	kg	kg	kg	kg	kg	kg	kg	kg	kg	kg	mm
9.0m									7240*	7240*	2218
7.5m	5930*	5930*	5780*	5780*					4160*	4160*	5009
6.0m	5030*	5030*	5830*	5830*	5040	3650			3500*	3270	6356
4.5m	8490*	8490*	7160*	5610	4970	3580			3250*	2670	7145
3.0m			7490	5200	4800	3430	3400	2430	3190*	2400	7557
1.5m			7100	4860	4630	3270	3350	2380	3250	2310	7654
0m			6920	4700	4520	3170			3360	2380	7449
- 1.5m	7580*	7580*	6770*	4700	4510	3160			3560*	2660	6914

LIFT CAPACITIES – DIPPER LENGTH: 2.70M, 5.35M T.A.B., TRACKSHOES: 700MM, NO BUCKET. JSI60 LC T.A.B.

Reach	3m		4.5m		6m		7.5m		Capacity at Max Reach		
											
Load Point Ht.	kg	kg	kg	kg	kg	kg	kg	kg	kg	kg	mm
9.0m	5360*	5360*							4260*	4260*	3449
7.5m			4780*	4780*					2990*	2990*	5649
6.0m			4650*	4650*	4580*	3720			2590*	2590*	6869
4.5m	5140*	5140*	5500*	5500*	5020	3630	3130*	2490	2440*	2420	7604
3.0m			7590	5300	4830	3450	3420	2450	2410*	2200	7992
1.5m			7150	4900	4640	3270	3340	2370	2480	2120	8084
0m			6910	4690	4500	3150	3280	2320	2670*	2170	7890
- 1.5m	7430*	7430*	6850	4640	4460	3110			3030*	2390	7388
- 3.0m			5210*	4720	3590*	3180			3160*	3020	6264

LIFT CAPACITIES – DIPPER LENGTH: 3.05M, 5.35M T.A.B., TRACKSHOES: 700MM, NO BUCKET. JSI60 LC T.A.B.

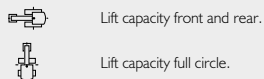

Reach	3m		4.5m		6m		7.5m		Capacity at Max Reach		
											
Load Point Ht.	kg	kg	kg	kg	kg	kg	kg	kg	kg	kg	mm
9.0m	5100*	5100*							3550*	3550*	4269
7.5m			4190*	4190*	3370*	3370*			2610*	2610*	6178
6.0m			3830*	3830*	4120*	3730			2260*	2260*	7309
4.5m	3140*	3140*	4240*	4240*	4500*	3620	3460	2480	2120*	2120*	8003
3.0m			7620	5310	4810	3430	3380	2410	2080*	1980	8372
1.5m			7120	4870	4590	3220	3280	2320	2110*	1920	8460
0m			6820	4590	4430	3070	3210	2250	2230*	1960	8275
- 1.5m	6500*	6500*	6720	4510	4360	3010	3200	2240	2480*	2140	7798
- 3.0m	7060*	7060*	5660*	4560	4070*	3050			2760*	2590	6857













Notes:

1. The above loads are in compliance with SAE and ISO Hydraulic Excavator Lift Capacity Standards.
2. They do not exceed 87% of hydraulic lifting capacity or 75% of tipping load.
3. Rated loads marked with an asterisk(*) are limited by hydraulic capacity rather than tipping load.











LIFT CAPACITIES – DIPPER LENGTH: 2.25M, 5.35M T.A.B., TRACKSHOES: 500MM, NO BUCKET. JSI60 NLC T.A.B.

Reach	3m		4.5m		6m		7.5m		Capacity at Max Reach		
											
Load Point Ht.	kg	kg	kg	kg	kg	kg	kg	kg	kg	kg	mm
9.0m									7240*	7240*	2218
7.5m	5930*	5930*	5780*	5150					4160*	4160*	5009
6.0m	5030*	5030*	5830*	5160	4890	3200			3500*	2860	6356
4.5m	8490*	8490*	7160*	4900	4820	3130			3250*	2320	7145
3.0m			7270	4510	4650	2980	3290	2110	3190*	2080	7557
1.5m			6880	4170	4880	2830	3240	2060	3140	2000	7654
0m			6700	4020	4380	2730			3250	2060	7449
- 1.5m	7580*	7500*	6700	4010	4370	2720			3560*	2290	6914

LIFT CAPACITIES – DIPPER LENGTH: 2.70M, 5.35M T.A.B., TRACKSHOES: 500MM, NO BUCKET. JSI60 NLC T.A.B.

Reach	3m		4.5m		6m		7.5m		Capacity at Max Reach		
											
Load Point Ht.	kg	kg	kg	kg	kg	kg	kg	kg	kg	kg	mm
9.0m	5360*	5360*							4260*	4260*	3449
7.5m			4780*	4780*					2990*	2990*	5649
6.0m			4650*	4650*	4580*	3270			2590*	2540	6869
4.5m	5140*	5140*	5500*	5000	4870	3180	3130*	2170	2440*	2100	7604
3.0m			7380	4590	4690	3010	3310	2120	2410*	1900	7992
1.5m			6930	4210	4490	2830	3230	2050	2480*	1820	8084
0m			6690	4000	4360	2710	3180	2000	2670*	1870	7890
- 1.5m	7430*	7350	6640	3960	4320	2670			3030*	2060	7388
- 3.0m			5210*	4030	3590*	2740			3160*	2600	6264

LIFT CAPACITIES – DIPPER LENGTH: 3.05M, 5.35M T.A.B., TRACKSHOES: 500MM, NO BUCKET. JSI60 NLC T.A.B.

Reach	3m		4.5m		6m		7.5m		Capacity at Max Reach		
											
Load Point Ht.	kg	kg	kg	kg	kg	kg	kg	kg	kg	kg	mm
9.0m	5100*	5100*							3550*	3550*	4269
7.5m			4190*	4190*	3370*	3210			2610*	2610*	6178
6.0m			3830*	3830*	4120*	3280			2260*	2240	7309
4.5m	3410*	3410*	4240*	4240*	4500*	3170	3350	2150	2120*	1880	8003
3.0m			7400	4600	4670	2980	3270	2080	2080*	1700	8372
1.5m			6910	4180	4450	2780	3180	1990	2110*	1640	8460
0m			6600	3910	4280	2630	3100	1920	2230*	1680	8275
- 1.5m	6500*	6500*	6510	3830	4210	2570	3090	1910	2480*	1830	7798
- 3.0m	7060*	7060*	5660*	3880	4070*	2610			2760*	2230	6857

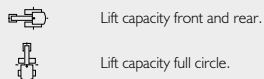









Notes: 1. The above loads are in compliance with SAE and ISO Hydraulic Excavator Lift Capacity Standards.
 2. They do not exceed 87% of hydraulic lifting capacity or 75% of tipping load.
 3. Rated loads marked with an asterisk(*) are limited by hydraulic capacity rather than tipping load.







LIFT CAPACITIES – DIPPER LENGTH: 2.25M, 5.15M MONOBOOM, TRACKSHOES: 700MM, NO BUCKET. JSI80 LC MONO

Reach	1.5m		3m		4.5m		6m		7.5m		Capacity at Max Reach		
													
Load Point Ht.	kg	kg	kg	kg	kg	kg	kg	kg	kg	kg	kg	kg	mm
7.5m					4040*	4040*					3860*	3860*	4537
6.0m											3330*	3330*	5985
4.5m					5560*	5560*	5010*	4050			3190*	3190*	6811
3.0m					6930*	5920	5550*	3920			3230*	2970	7235
1.5m					8220*	5610	5900	3780			3440*	2860	7330
0m			5370*	5370*	8840*	5450	5800	3690			3870*	2950	7108
- 1.5m	6090*	6090*	10850*	10150	8690*	5420	5780	3670			4740*	3290	6537
- 3.0m			10740*	10320	7590*	5500					5830*	4200	5507

LIFT CAPACITIES – DIPPER LENGTH: 2.70M, 5.15M MONOBOOM, TRACKSHOES: 700MM, NO BUCKET. JSI80 LC MONO

Reach	1.5m		3m		4.5m		6m		7.5m		Capacity at Max Reach		
													
Load Point Ht.	kg	kg	kg	kg	kg	kg	kg	kg	kg	kg	kg	kg	mm
7.5m											2800*	2800*	5165
6.0m							3880*	3880*			2490*	2490*	6471
4.5m					5000*	5000*	4620*	4080			2400*	2400*	7241
3.0m			9720*	9720*	6400*	5990	5220*	3940	3220*	2820	2450*	2450*	7641
1.5m			5040*	5040*	7830*	5650	5900*	3790	4000*	2760	2600*	2600*	7731
0m			6450*	6450*	8670*	5440	5780	3670	3100*	2720	2920*	2710	7521
- 1.5m	5830*	5830*	10170*	10040	8770*	5370	5730	3630			3520*	2980	6985
- 3.0m	9880*	9880*	11560*	10180	8020*	5420	5360*	3680			4880*	3660	6033
- 4.5m			8370*	8370*							5580*	5580*	4396

LIFT CAPACITIES – DIPPER LENGTH: 3.05M, 5.15M MONOBOOM, TRACKSHOES: 700MM, NO BUCKET. JSI80 LC MONO

Reach	1.5m		3m		4.5m		6m		7.5m		Capacity at Max Reach		
													
Load Point Ht.	kg	kg	kg	kg	kg	kg	kg	kg	kg	kg	kg	kg	mm
7.5m											2430*	2430*	5738
6.0m							3890*	3890*			2160*	2160*	6935
4.5m							4270*	4060	2730*	2730*	2070*	2070*	7657
3.0m			8600*	8600*	5910*	5910*	4900*	3910	3940*	2780	2080*	2080*	8037
1.5m			6010*	6010*	7410*	5600	5620*	3730	4200	2710	2180*	2180*	8122
0m			6180*	6180*	8410*	5360	5710	3600	4130	2640	2390*	2390*	7923
- 1.5m	4960*	4960*	9110*	9110*	8680*	5260	5640	3530			2800*	2670	7416
- 3.0m	8470*	8470*	11930*	9950	8160*	5280	5670	3560			3630*	3200	6528
- 4.5m			9250*	9250*	6250*	5460					5160*	4660	5059

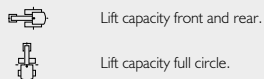











Notes:

1. The above loads are in compliance with SAE and ISO Hydraulic Excavator Lift Capacity Standards.
2. They do not exceed 87% of hydraulic lifting capacity or 75% of tipping load.
3. Rated loads marked with an asterisk(*) are limited by hydraulic capacity rather than tipping load.









LIFT CAPACITIES – DIPPER LENGTH: 2.25M, 5.15M MONOBOOM, TRACKSHOES: 500MM, NO BUCKET. JSI80 NLC MONO

Reach	1.5m		3m		4.5m		6m		7.5m		Capacity at Max Reach			
														
Load Point Ht.	kg	kg	kg	kg	kg	kg	kg	kg	kg	kg	kg	kg	kg	mm
7.5m					4040*	4040*						3860*	3860*	4537
6.0m												3330*	3330*	5985
4.5m					5560*	5520	5010*	3580				3190*	2930	6811
3.0m					6930*	5200	5550*	3460				3230*	2620	7235
1.5m					8220*	4910	5660	3330				3440*	2520	7330
0m			5370*	5370*	8630	4750	5560	3240				3870*	2590	7108
- 1.5m	6090*	6090*	10850*	8680	8590	4720	5530	3220				4740*	2890	6537
- 3.0m			10740*	8840	7590*	4800						5830*	3690	5507

LIFT CAPACITIES – DIPPER LENGTH: 2.70M, 5.15M MONOBOOM, TRACKSHOES: 500MM, NO BUCKET. JSI80 NLC MONO

Reach	1.5m		3m		4.5m		6m		7.5m		Capacity at Max Reach			
														
Load Point Ht.	kg	kg	kg	kg	kg	kg	kg	kg	kg	kg	kg	kg	kg	mm
7.5m												2800*	2800*	5165
6.0m							3880*	3680				2490*	2490*	6471
4.5m					5000*	5000*	4620*	3620				2400*	2400*	7241
3.0m			9720*	9640*	6400*	5270	5220*	3480	3220*	2490		2450*	2410	7641
1.5m			5040*	5040*	7830*	4940	5670	3330	4000*	2430		2600*	2320	7731
0m			6450*	6450*	8630	4740	5540	3220	3100*	2380		2920*	2370	7521
- 1.5m	5830*	5830*	10170*	8580	8540	4670	5490	3170				3520*	2610	6985
- 3.0m	9880*	9880*	11560*	8700	8020*	4720	5360*	3230				4880*	3200	6033
- 4.5m			8370*	8370*								5580*	5100	4396

LIFT CAPACITIES – DIPPER LENGTH: 3.05M, 5.15M MONOBOOM, TRACKSHOES: 500MM, NO BUCKET. JSI80 NLC MONO

Reach	1.5m		3m		4.5m		6m		7.5m		Capacity at Max Reach			
														
Load Point Ht.	kg	kg	kg	kg	kg	kg	kg	kg	kg	kg	kg	kg	kg	mm
7.5m												2430*	2430*	5738
6.0m							3890*	3680				2160*	2160*	6935
4.5m							4270*	3600	2730*	2500		2070*	2070*	7657
3.0m			8600*	8600*	5910*	5270	4900*	3450	3940*	2450		2080*	2080*	8037
1.5m			6010*	6010*	7410*	4900	5620*	3270	4020	2370		2180*	2100	8122
0m			6180*	6180*	8410*	4660	5470	3140	3950	2310		2390*	2140	7923
- 1.5m	4960*	4960*	9110*	8370	8420	4560	5390	3080				2800*	2330	7416
- 3.0m	8470*	8470*	11930*	8480	8160*	4580	5420	3100				3630*	2800	6528
- 4.5m			9250*	8760	6250*	4750						5160*	4080	5059

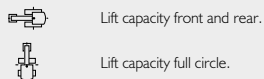











Notes:

1. The above loads are in compliance with SAE and ISO Hydraulic Excavator Lift Capacity Standards.
2. They do not exceed 87% of hydraulic lifting capacity or 75% of tipping load.
3. Rated loads marked with an asterisk(*) are limited by hydraulic capacity rather than tipping load.











LIFT CAPACITIES – DIPPER LENGTH: 2.25M, 5.35M T.A.B., TRACKSHOES: 700MM, NO BUCKET. JS180 LC T.A.B.

Reach	3m		4.5m		6m		7.5m		Capacity at Max Reach		
											
Load Point Ht.	kg	kg	kg	kg	kg	kg	kg	kg	kg	kg	mm
9.0m									7030*	7030*	2326
7.5m	5900*	5900*	5800*	5800*					4130*	4130*	5047
6.0m	5030*	5030*	5830*	5830*	5250*	4030			3490*	3490*	6377
4.5m	8900*	8900*	7240*	6160	6040*	3970			3250*	2980	7157
3.0m			8340*	5750	6000	3810	3920*	2730	3200*	2690	7562
1.5m			8680	5410	5830	3650	5210	2680	3280*	2600	7653
0m			8130*	5260	5720	3560			3540*	2690	7441
- 1.5m	7710*	7710*	6730*	5250	5010*	3550			3550*	3000	6898

LIFT CAPACITIES – DIPPER LENGTH: 2.70M, 5.35M T.A.B., TRACKSHOES: 700MM, NO BUCKET. JS180 LC T.A.B.

Reach	3m		4.5m		6m		7.5m		Capacity at Max Reach		
											
Load Point Ht.	kg	kg	kg	kg	kg	kg	kg	kg	kg	kg	mm
9.0m	5400*	5400*							4200*	4220*	3157
7.5m			4780*	4780*					2980*	2980*	5682
6.0m			4660*	4660*	4600*	4110			2590*	2590*	6889
4.5m	5420*	5240*	5540*	5540*	5340*	4010	3190*	2790	2440*	2440*	7616
3.0m			8040*	5840	6040	3840	2480	2740	2410*	2410*	7997
1.5m			8620*	5450	5840	3660	4200	2670	2480*	2390	8083
0m			8360*	5240	5700	3540	4140	2620	2670*	2460	7883
- 1.5m	7520*	7520*	7230*	5190	5390*	3500			3050*	2700	7373
- 3.0m			5150*	5150*	3530*	3530*			3190*	3190*	6210

LIFT CAPACITIES – DIPPER LENGTH: 3.05M, 5.35M T.A.B., TRACKSHOES: 700MM, NO BUCKET. JS180 LC T.A.B.

Reach	3m		4.5m		6m		7.5m		Capacity at Max Reach		
											
Load Point Ht.	kg	kg	kg	kg	kg	kg	kg	kg	kg	kg	mm
9.0m	5080*	5080*							3510*	3510*	4324
7.5m			4180*	4180*	3440*	3440*			2600*	2600*	6208
6.0m			3830*	3830*	4120*	4120			2260*	2260*	7327
4.5m	3440*	3440*	4260*	4260*	4520*	4000	3820*	2780	2110*	2110*	8014
3.0m			7710*	5850	5900*	3810	4240	2700	2070*	2070*	8377
1.5m			8430*	5410	5790	3610	4150	2610	2110*	2110*	8459
0m			8370*	5150	5620	3460	4070	2540	2240*	2230	8268
- 1.5m	6580*	6580*	7440*	5070	5530*	3400	3810*	2510	2490*	2440	7784
- 3.0m	6990*	6990*	5610*	5130	4030*	3440			2780*	2780*	6815

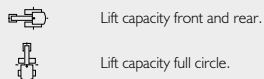











Notes: 1. The above loads are in compliance with SAE and ISO Hydraulic Excavator Lift Capacity Standards.
 2. They do not exceed 87% of hydraulic lifting capacity or 75% of tipping load.
 3. Rated loads marked with an asterisk(*) are limited by hydraulic capacity rather than tipping load.











LIFT CAPACITIES – DIPPER LENGTH: 2.25M, 5.35M T.A.B., TRACKSHOES: 500MM, NO BUCKET. JSI80 NLC T.A.B.

Reach	3m		4.5m		6m		7.5m		Capacity at Max Reach		
											
Load Point Ht.	kg	kg	kg	kg	kg	kg	kg	kg	kg	kg	mm
9.0m									7030*	7030*	2326
7.5m	5900*	5900*	5800*	5680					4130*	4130*	5047
6.0m	5030*	5030*	5830*	5680	5250*	3560			3490*	3180	6377
4.5m	8900*	8900*	7240*	5420	5930	3500			3250*	2610	7157
3.0m			8340*	5030	5760	3340	3920*	2390	3200*	2350	7562
1.5m			8680	4700	5580	3190	4030	2340	3280*	2270	7653
0m			8130*	4550	5470	3100			3540*	2340	7441
- 1.5m	7710*	7710*	6730*	4540	5010*	3090			3550*	2610	6898

LIFT CAPACITIES – DIPPER LENGTH: 2.70M, 5.35M T.A.B., TRACKSHOES: 500MM, NO BUCKET. JSI80 NLC T.A.B.

Reach	3m		4.5m		6m		7.5m		Capacity at Max Reach		
											
Load Point Ht.	kg	kg	kg	kg	kg	kg	kg	kg	kg	kg	mm
9.0m	5400*	5400*							4220*	4220*	3157
7.5m			4780*	4780*					2980*	2980*	5682
6.0m			4660*	4660*	4600*	3630			2590*	2590*	6889
4.5m	5420*	5240*	5540*	5520	5340*	3540	3190*	2450	2440*	2370	7616
3.0m			8040*	5110	5790	3370	4100	2400	2410*	2160	7997
1.5m			8620*	4740	5590	3200	4020	2330	2480*	2080	8083
0m			8630*	4530	5460	3080	3960	2280	2670*	2140	7883
- 1.5m	7520*	7520*	7230*	4490	5390*	3040			3050*	5350	7373
- 3.0m			5150*	4570	3530*	3110			3190*	2980	6210

LIFT CAPACITIES – DIPPER LENGTH: 3.05M, 5.35M T.A.B., TRACKSHOES: 500MM, NO BUCKET. JSI80 NLC T.A.B.

Reach	3m		4.5m		6m		7.5m		Capacity at Max Reach		
											
Load Point Ht.	kg	kg	kg	kg	kg	kg	kg	kg	kg	kg	mm
9.0m	5080*	5080*							3510*	3510*	4324
7.5m			4180*	4180*	3440*	3440*			2600*	2600*	6208
6.0m			3830*	3830*	4120*	3640			2260*	2260*	7327
4.5m	3440*	3440*	4260*	4260*	4520*	3530	3820*	2430	2110*	2110*	8014
3.0m			7710*	5120	5770	3340	4060	2360	2070*	1950	8377
1.5m			8430*	4700	5550	3140	3960	2270	2110*	1880	8459
0m			8370*	4440	5380	3000	3890	2220	2240*	1930	8268
- 1.5m	6580*	6580*	7440*	4360	5310	2940	3810*	2190	2490*	2110	7784
- 3.0m	6990*	6990*	5610*	4420	4030*	2980			2780*	2560	6815

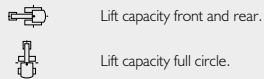

Notes: 1. The above loads are in compliance with SAE and ISO Hydraulic Excavator Lift Capacity Standards.
 2. They do not exceed 87% of hydraulic lifting capacity or 75% of tipping load.
 3. Rated loads marked with an asterisk(*) are limited by hydraulic capacity rather than tipping load.





JCB

710-100

JCB

7100MAX



1200 RPM 15.3 L/h

10:30

John Deere logo

Navigation icons: back, home, forward





ONE COMPANY, OVER 300 MACHINES.

Your nearest JCB dealer

Tracked Excavator JS160/180 NLC/LC

Operating weight: 17,866 - 20,480 Engine power: 97kW (130hp) Bucket capacity: 0.25 – 0.99m³

JCB Sales Limited, Rocester, Staffordshire, United Kingdom ST14 5JP.

Tel: +44 (0)1889 590312 Email: salesinfo@jcb.com

Download the very latest information on this product range at: www.jcb.com

©2009 JCB Sales. All rights reserved. No part of this publication may be reproduced, stored in a retrieval system, or transmitted in any form or by any other means, electronic, mechanical, photocopying or otherwise, without prior permission from JCB Sales. All references in this publication to operating weights, sizes, capacities and other performance measurements are provided for guidance only and may vary dependant upon the exact specification of machine. They should not therefore be relied upon in relation to suitability for a particular application. Guidance and advice should always be sought from your JCB Dealer. JCB reserves the right to change specifications without notice. Illustrations and specifications shown may include optional equipment and accessories. All images are correct at time of print. The JCB logo is a registered trademark of J.C. Bamford Excavators Ltd.

